

Subject: Site Planning and Landscape Design

Topic: Paving

Presented by: Hiba Gul

PAVINGS

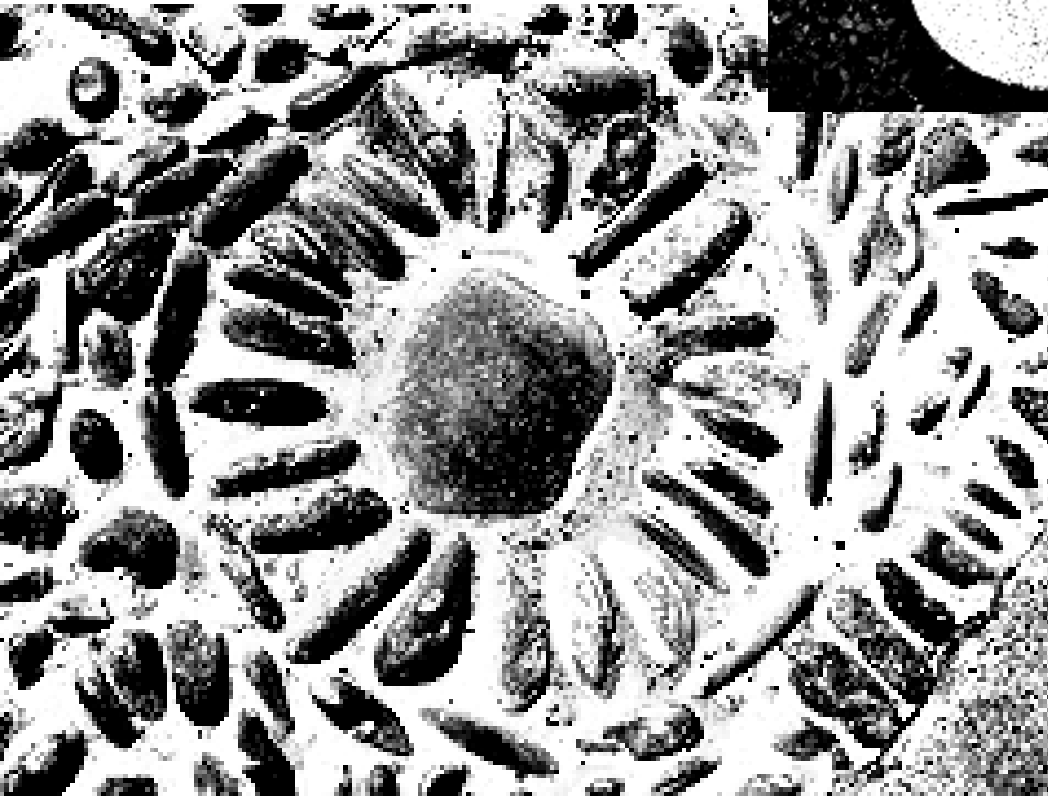
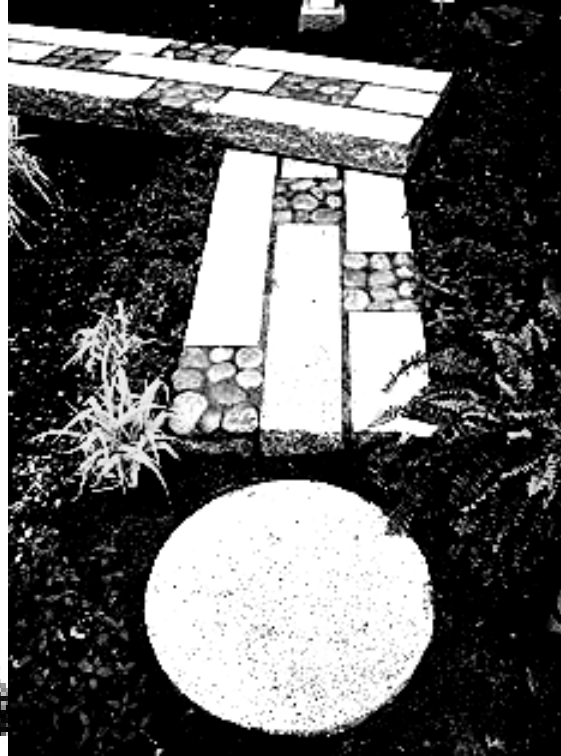

ABHINAV CHAUDHARY
AKASHDEEP
AKSHAT JAIN
ALOK KUMAR
AMIT KUMAR SINGH
ANAMIKA SINGH

DETAILS

dholpur sand stone

m.s flat

niche

25 th. glass

wooden planks

black flamed granite
neoprene track coat
bituminous setting bed
asphalt conc. porous surface

compacted aggregate if required
rigid insulation
water proof membrane
light wt. conc. fill sloped to drain
structutral slab

stone pabbles

concrete

stone pabbles

concrete

stone pabbles

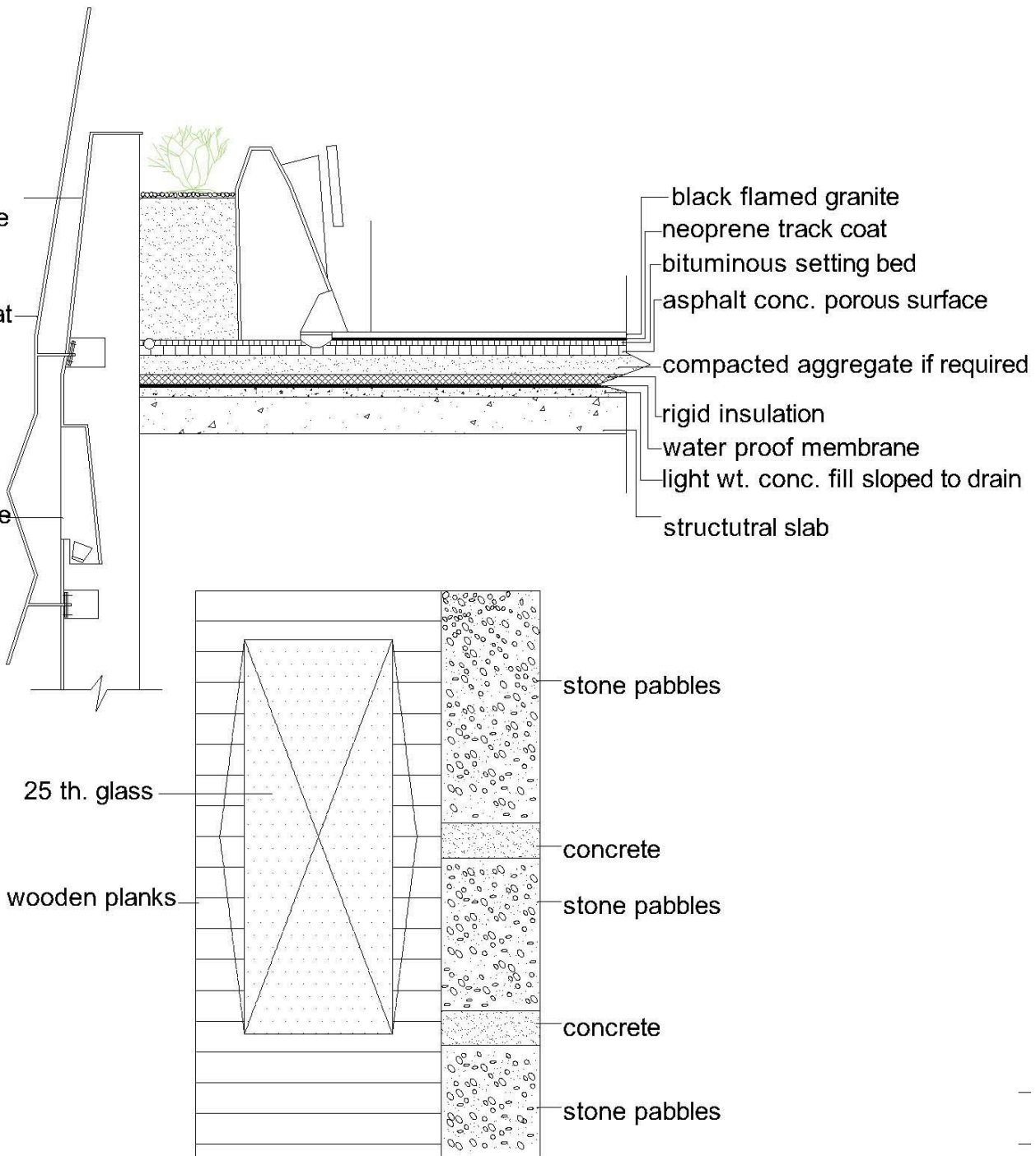

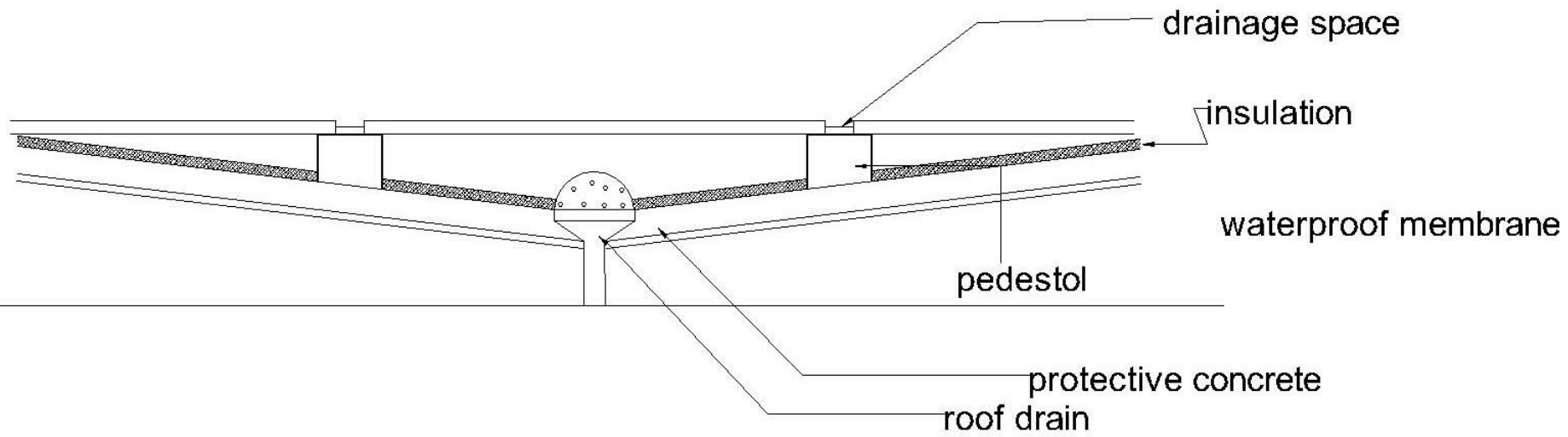

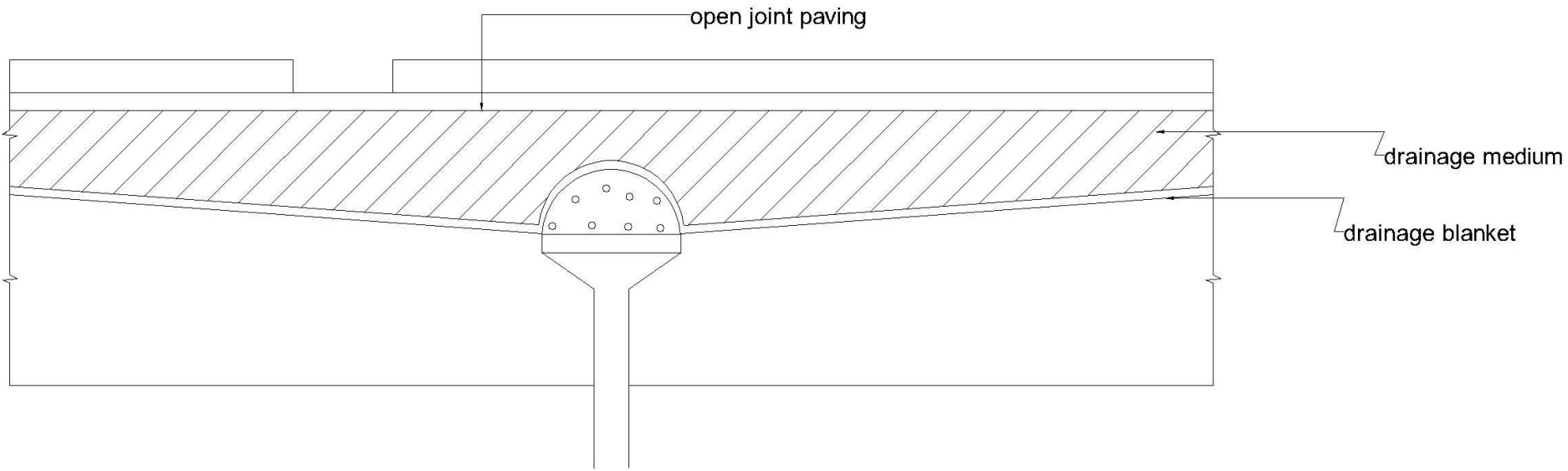

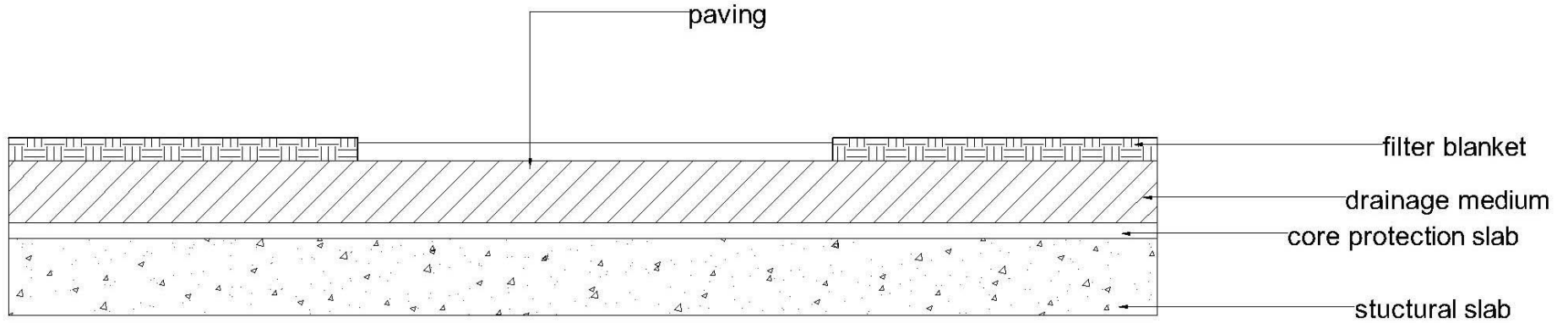

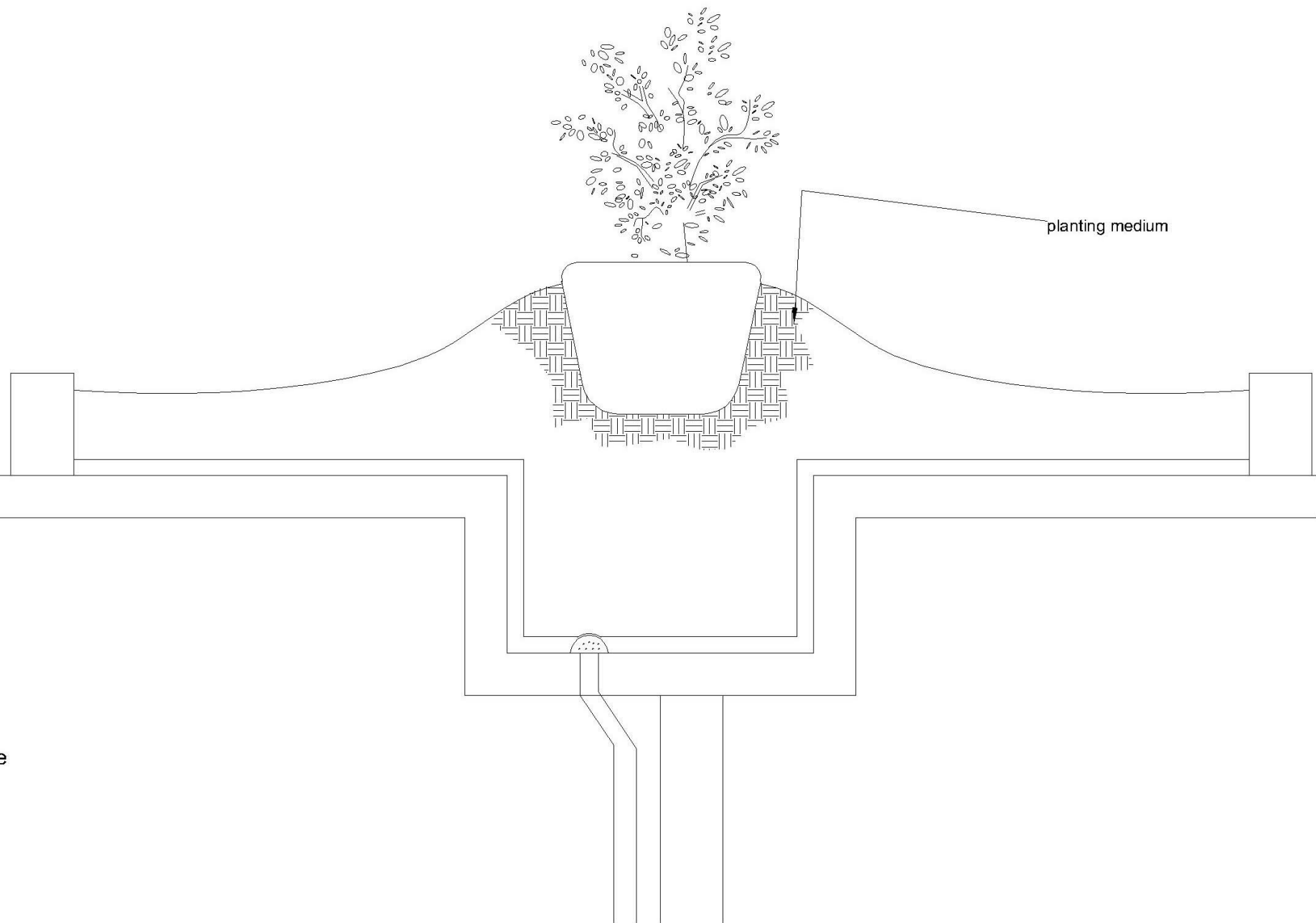

planting medium

e

